

1.- Introduction

1.1.- Goals

Many developers around the world choose LeJOS, Java for Lego Mindstorm as the platform to develop programs with NXT Lego Mindstorm. I consider that this eBook will help LeJOS community to develop better programs with LeJOS.

1.2.- LeJOS Project

LeJOS is Sourceforge project created to develop a technological infrastructure to develop software into Lego Mindstorm Products using Java technology.

Currently leJOS has opened the following research lines:

1. NXT Technology
 - a. NXJ
 - b. iCommand
2. RCX Technology
 - a. leJOS for RCX

This eBook will focus in NXT technology with NXJ using a Windows Environment.

1.3.- NXT Brick

The NXT is the brain of a MINDSTORMS® robot. It's an intelligent, computer-controlled LEGO® brick that lets a MINDSTORMS robot come alive and perform different operations.



Motor ports

The NXT has three output ports for attaching motors - Ports A, B and C

Sensor ports

The NXT has four input ports for attaching sensors - Ports 1, 2, 3 and 4.

USB port

Connect a USB cable to the USB port and download programs from your computer to the NXT (or upload data from the robot to your computer). You can also use the wireless Bluetooth connection for uploading and downloading.

Loudspeaker

Make a program with real sounds and listen to them when you run the program

NXT Buttons

Orange button: On/Enter /Run

Light grey arrows: Used for moving left and right in the NXT menu

Dark grey button: Clear/Go back

NXT Display

Your NXT comes with many display features - see the MINDSTORMS NXT Users Guide that comes with your NXT kit for specific information on display icons and options

Technical specifications

- 32-bit ARM7 microcontroller
- 256 Kbytes FLASH, 64 Kbytes RAM
- 8-bit AVR microcontroller
- 4 Kbytes FLASH, 512 Byte RAM
- Bluetooth wireless communication (Bluetooth Class II V2.0 compliant)
- USB full speed port
- 4 input ports, 6-wire cable digital platform (One port includes a IEC 61158 Type 4/EN 50 170 compliant expansion port for future use)
- 3 output ports, 6-wire cable digital platform
- 100 x 64 pixel LCD graphical display
- Loudspeaker - 8 kHz sound quality. Sound channel with 8-bit resolution and 2-16 KHz sample rate.
- Power source: 6 AA batteries

1.3.1.- NXT Sensors used in the eBook

NXT Sensors used in the document are the following:

- NXT Motor
- Ultrasonic Sensor
- Compass Sensor
- NXTCam
- Tilt Sensor
- NXTCam
- RFID Sensor

NXT Motor



Ultrasonic Sensor



Compass Sensor

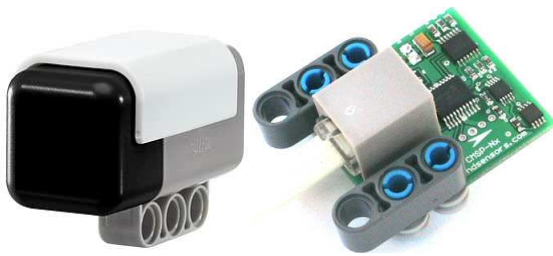

Tilt Sensor



NXTCam



RFID Sensor



1.4.- About the authors



Juan Antonio Breña Moral collaborates in LeJOS Research team since 2006. He works in Europe developing Engineering and IT solutions for middle and large customers in several markets as Defence, Telecommunications, Pharmaceuticals, Energy, Automobile, Construction, Insurance and Internet.

Further information:

www.juanantonio.info

www.esmeta.es



Frank Zimmermann is a Doctor in Mathematics and Professor for CIS at the University of Applied Sciences Nordakademie since 1996. Frank teaches Java, Software Engineering and Information Systems at the university. He discovered leJOS and NXT Technology in 2007.

Further information:

<http://fermat.nordakademie.de/>

<http://www.nordakademie.de/>

2.- How to install the toolkit

2.1.- Introduction

LeJOS Statemachine development toolkit is a visual modelling of leJOS applications based on statemachines.

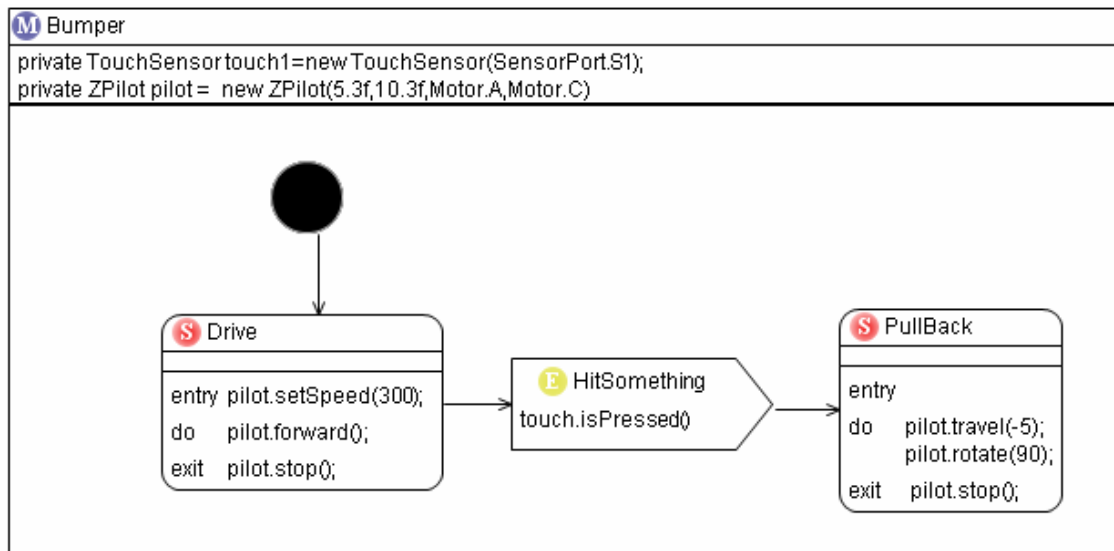

This toolkit use Eclipse IDE and some plugins. In this article we explain how to install the toolkit in your computer.

2.2.- Eclipse

Eclipse is an open source community development platform designed to manage software across the lifecycle. Download Eclipse Europa 3.3 Classic from eclipse's website. Use the following URL: <http://www.eclipse.org/downloads/>

Once you have installed the IDE in your computer it is necessary to install the following features on eclipse:

- GMF, Graphics Modelling Framework
- OWA

Finally we will install leJOS statemachine development toolkit feature on Eclipse IDE

2.3.- GMF, Graphics Modeling Framework

Eclipse Graphical Modeling Framework (GMF) provides a generative component and runtime infrastructure for developing graphical editors based on EMF and GEF. The project aims to provide these components, in addition to exemplary tools for select domain models which illustrate its capabilities

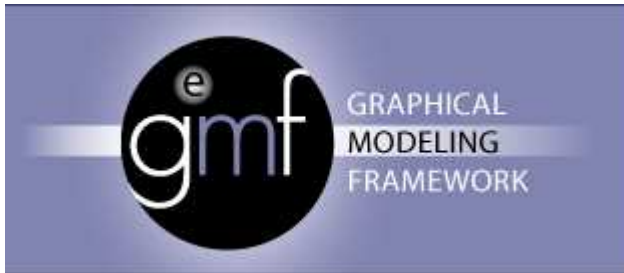

<http://www.eclipse.org/gmf/>

<http://download.eclipse.org/modeling/gmf/downloads/index.php>

The most easy way to install GMF is using the option on eclipse Find and install.



How to install leJOS statemachine development toolkit

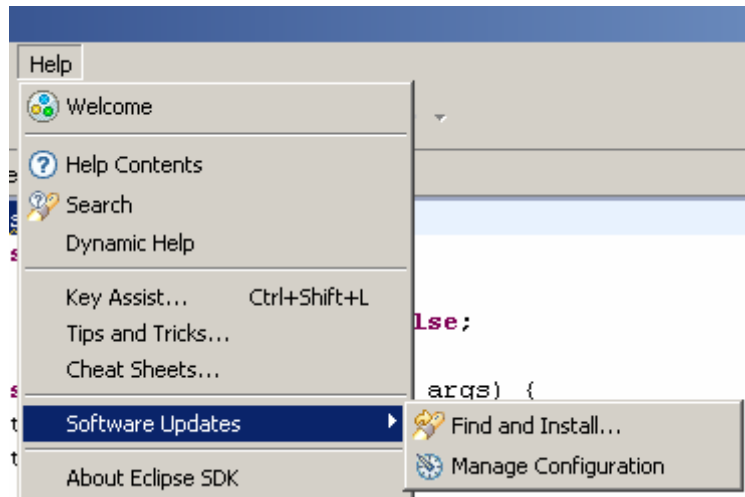

When you click in the option then, Eclipse will init an assistant to install new features.

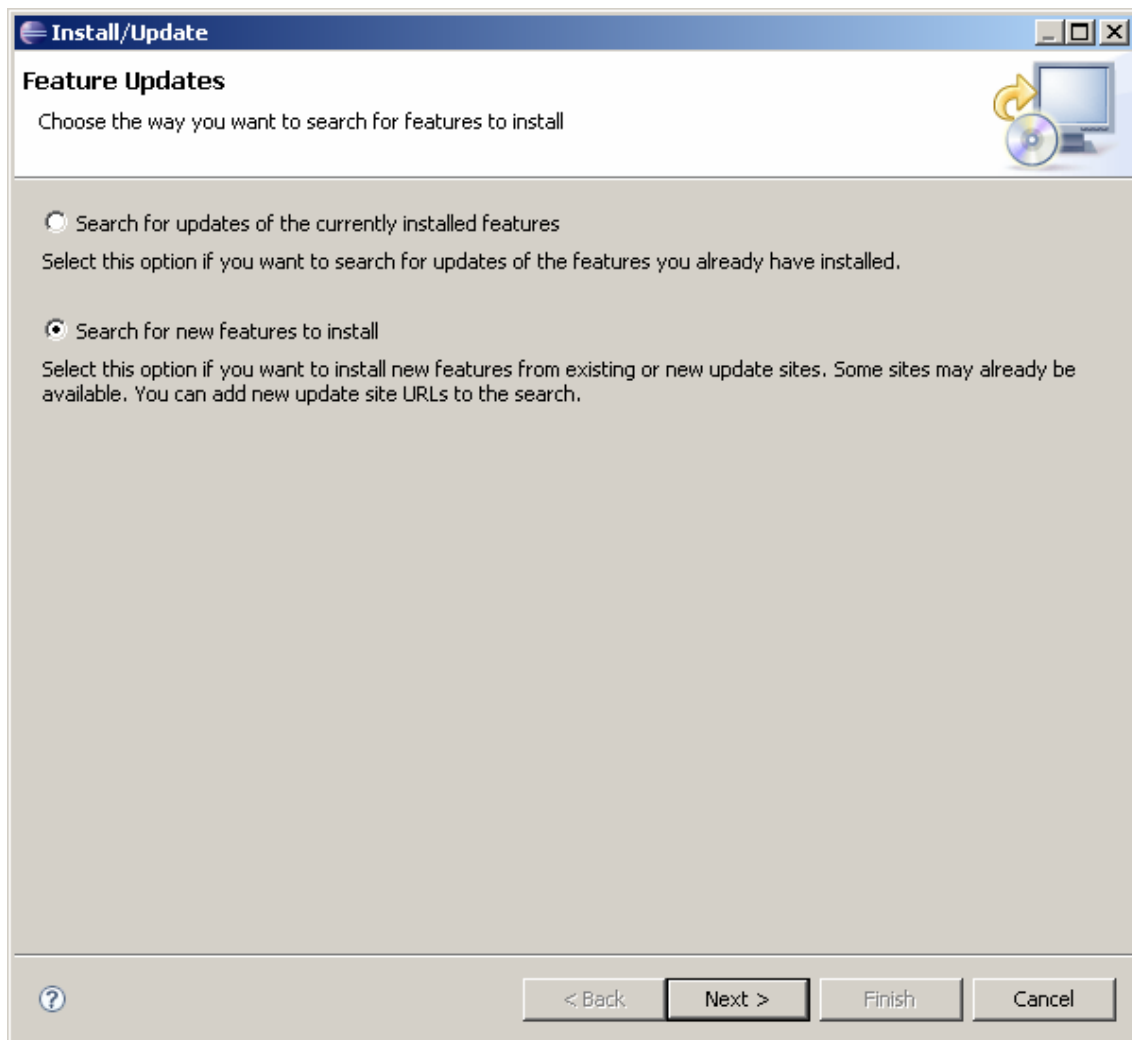

Select Search for new features to install and click in the button Next

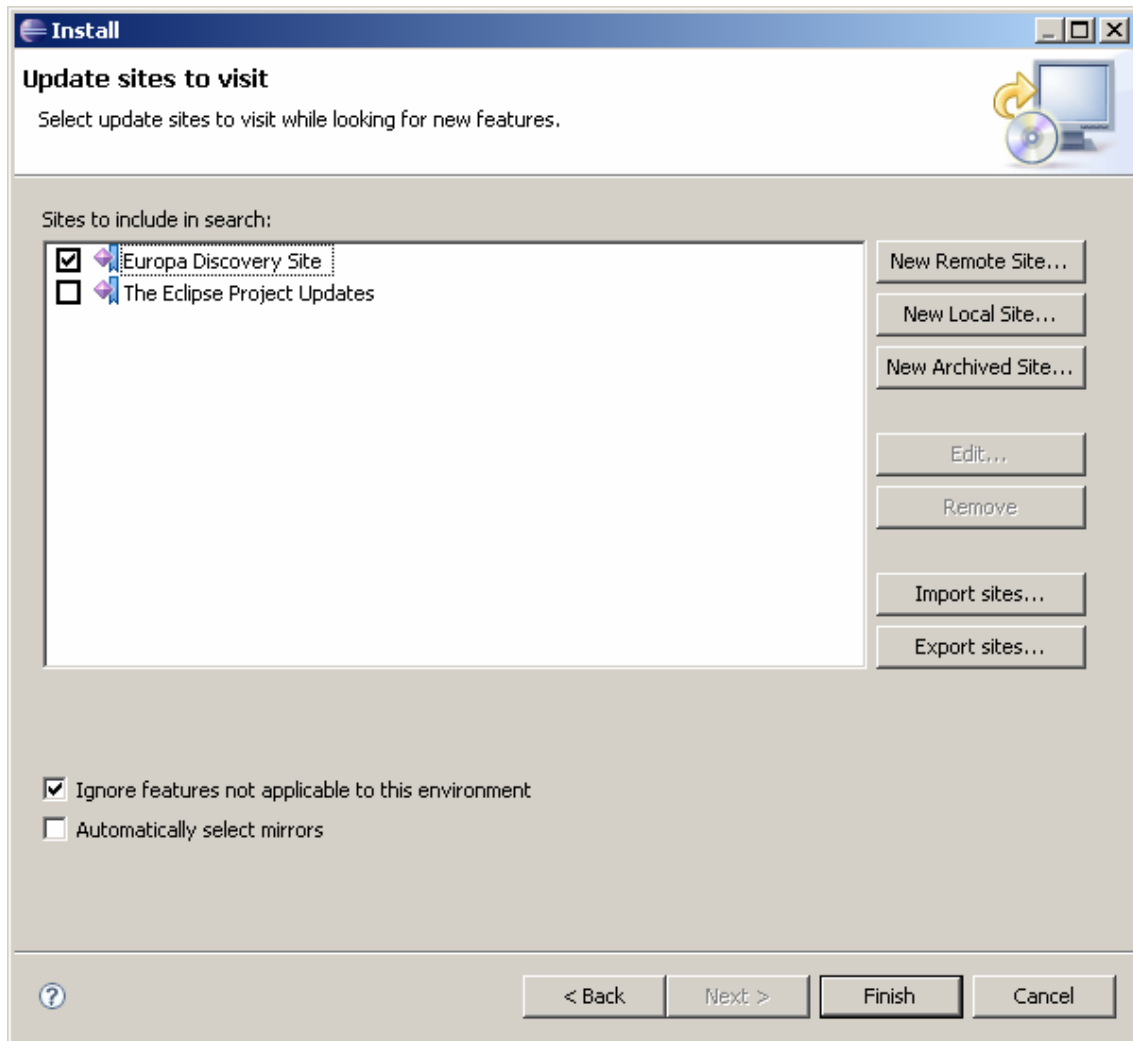

Select Europe Discovery Site and click in the button Finish to show a list of server to search latest release of GMF

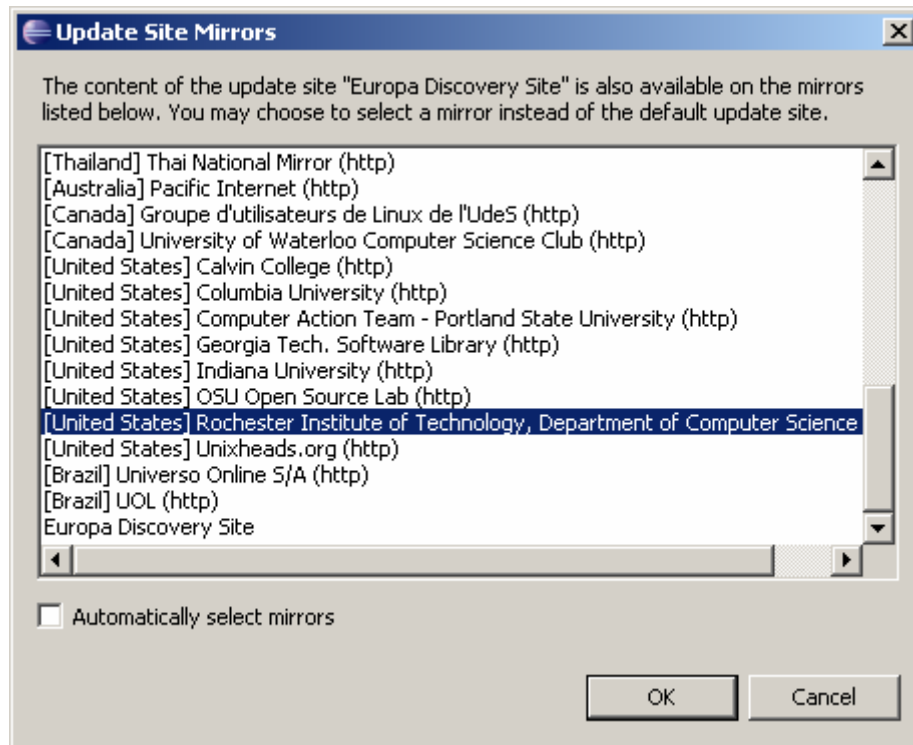

Select your favorite server and select the feature:

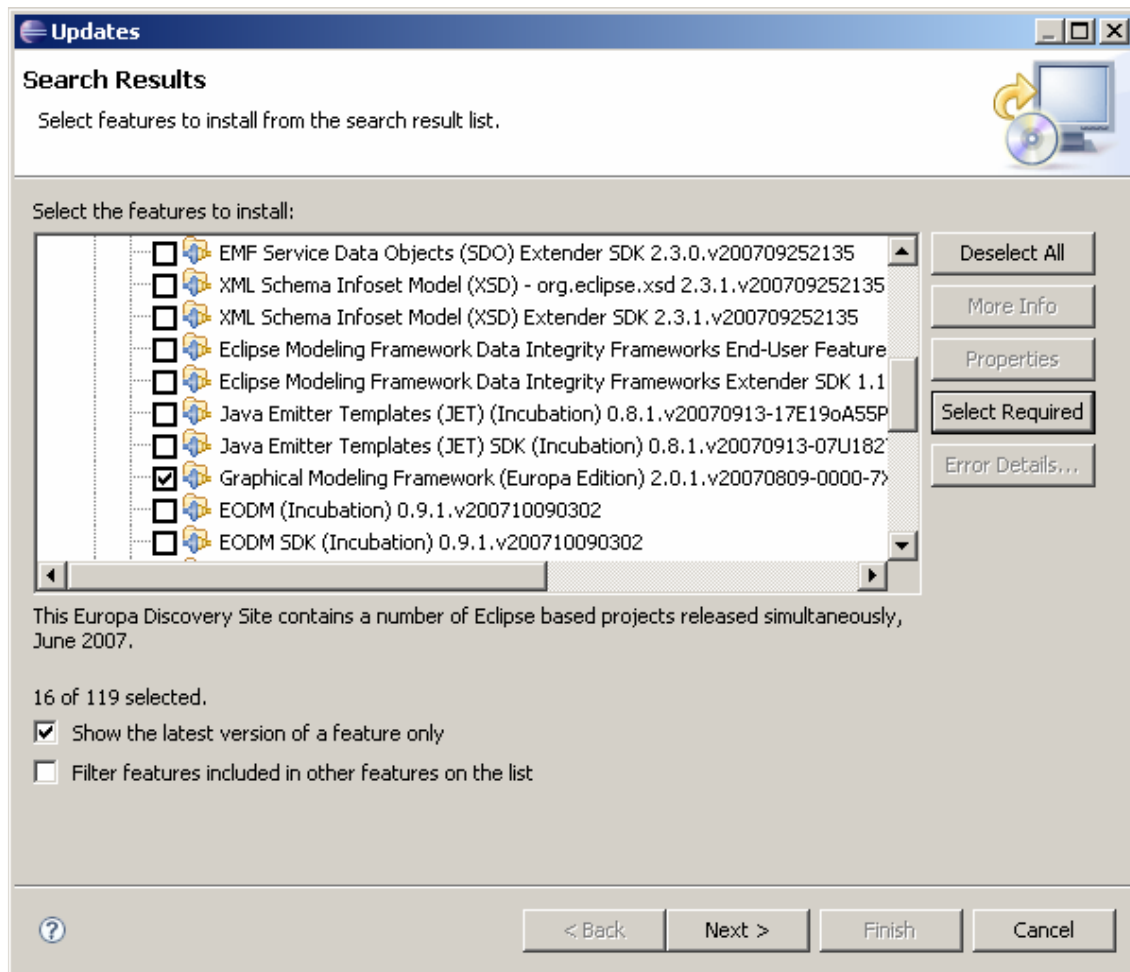

When you finish the installation process, it is necessary to restart the IDE.

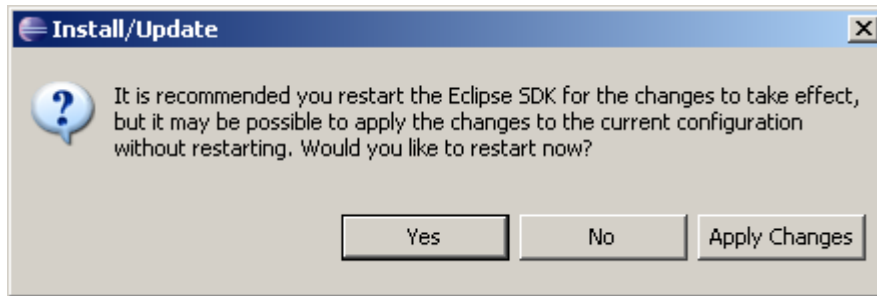

2.4.- OAW, Open Architecture Ware

Open Architecture Ware (oAW) is a suite of tools to assist model-driven software development. It is a "tool for building MDS/MDA tools". OAW is built upon a modular MDS generator framework and is implemented in Java.



In this case, OWA should be installed with a different way in relation to GMF.

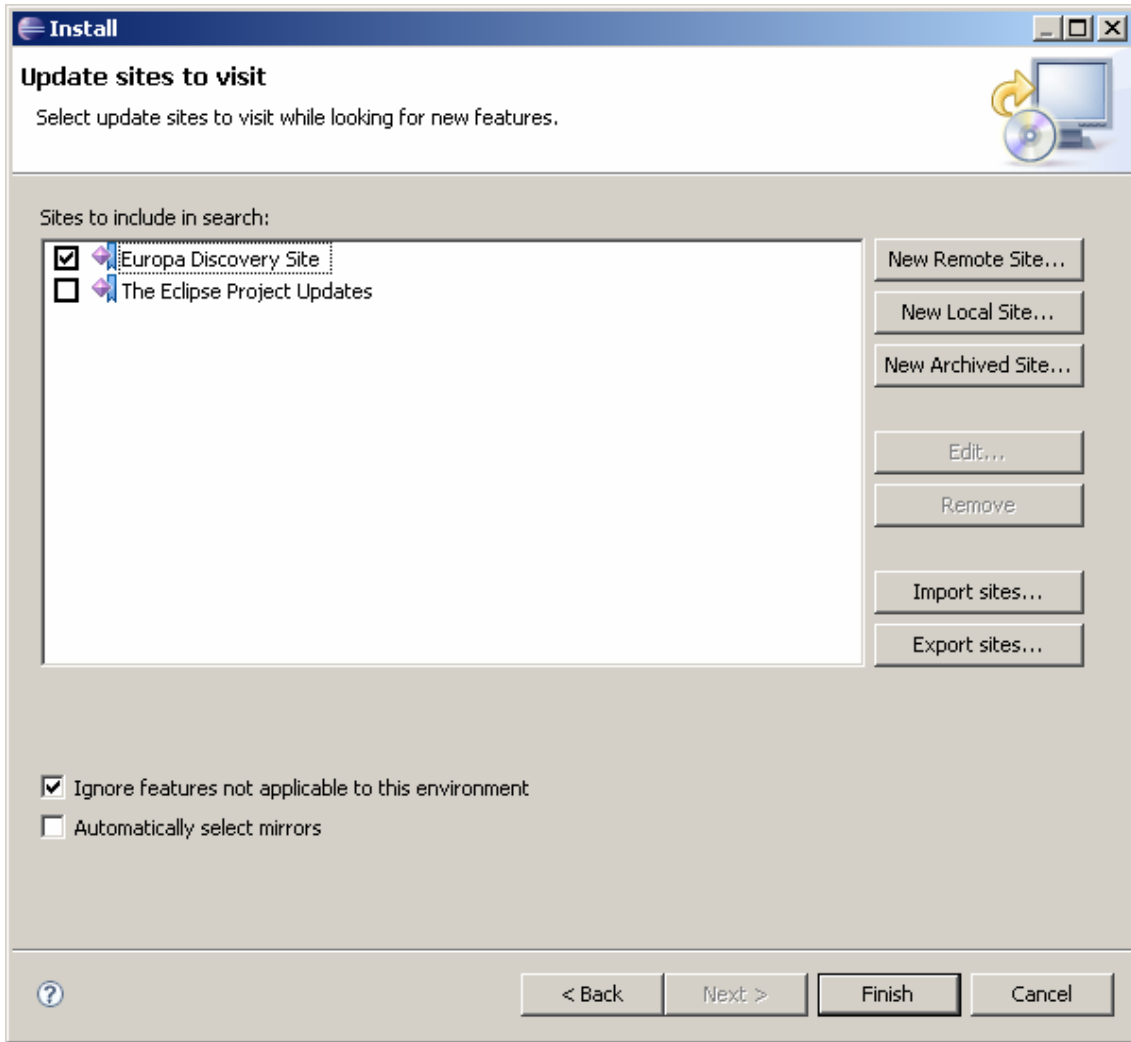

When you are in this window, click in "New remote site" button and edit a empty window with the following URL:

<http://www.openarchitectureware.org/updatesite/milestone/site.xml>

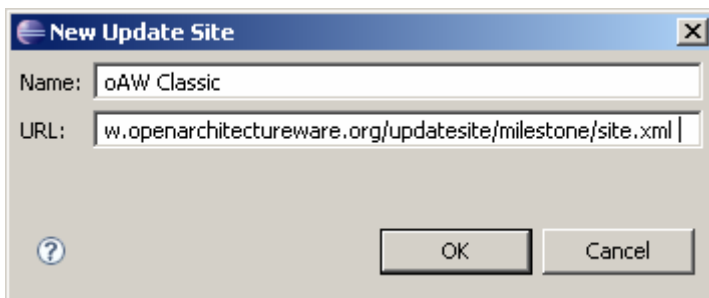

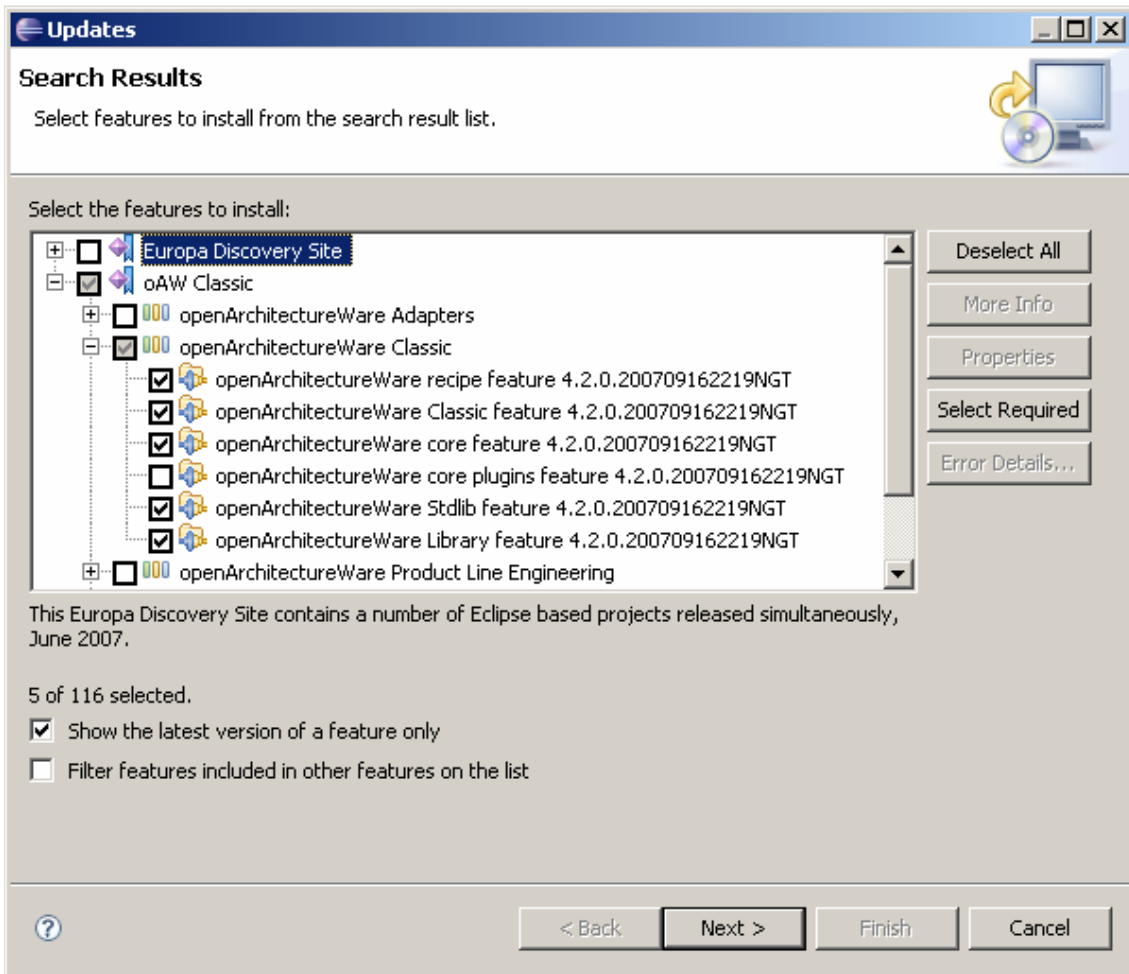

Expand the node and install the "oAW Cassic feature" (you need to expand the oAW Classic one step further, to see the oAW Classic feature).When you click on select required, there will be two more feaures selected.

When you finish, restart Eclipse.

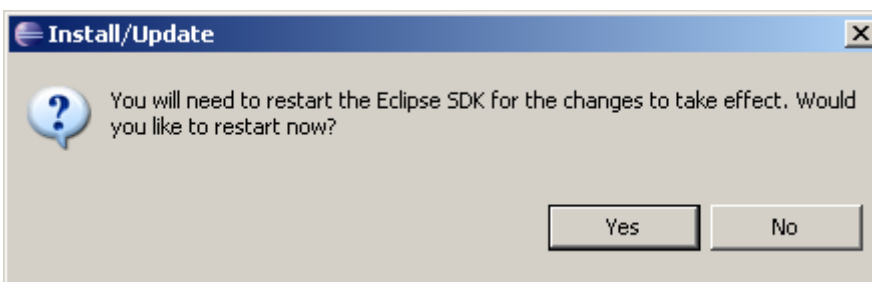

2.5.- LeJOS Statemachine development toolkit

Finally when you have installed the prerequisites, it is the moment to install the the toolkit.

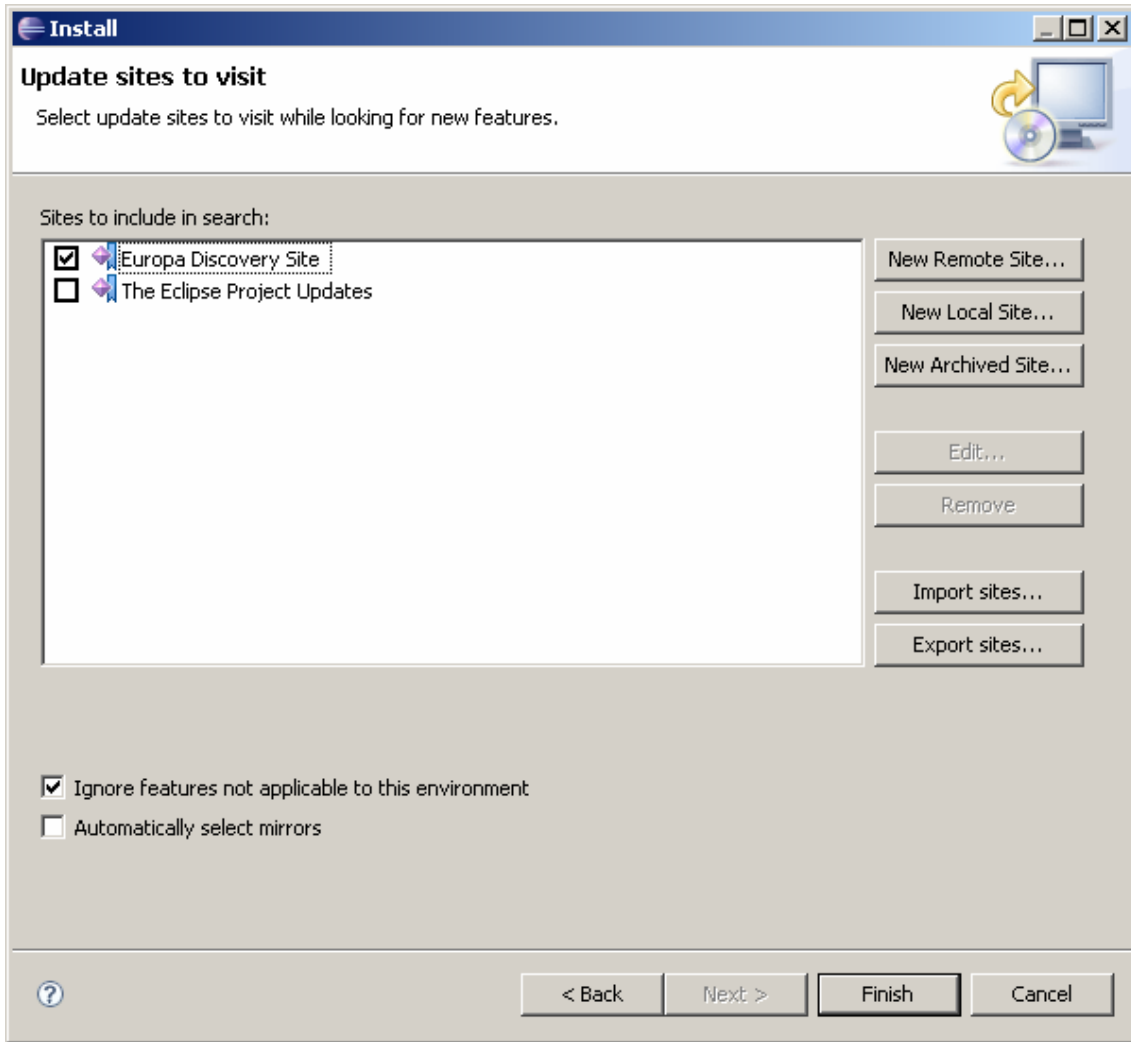

When you are in this window, click in "New remote site" button and edit a empty window with the following URL:

<http://fermat.nordakademie.de/update/site.xml>

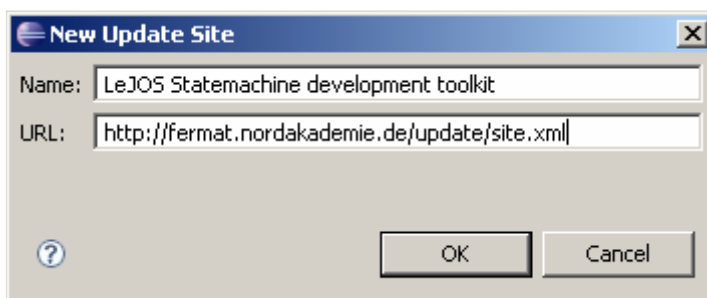

When you confirm the data, you will see all features to install:

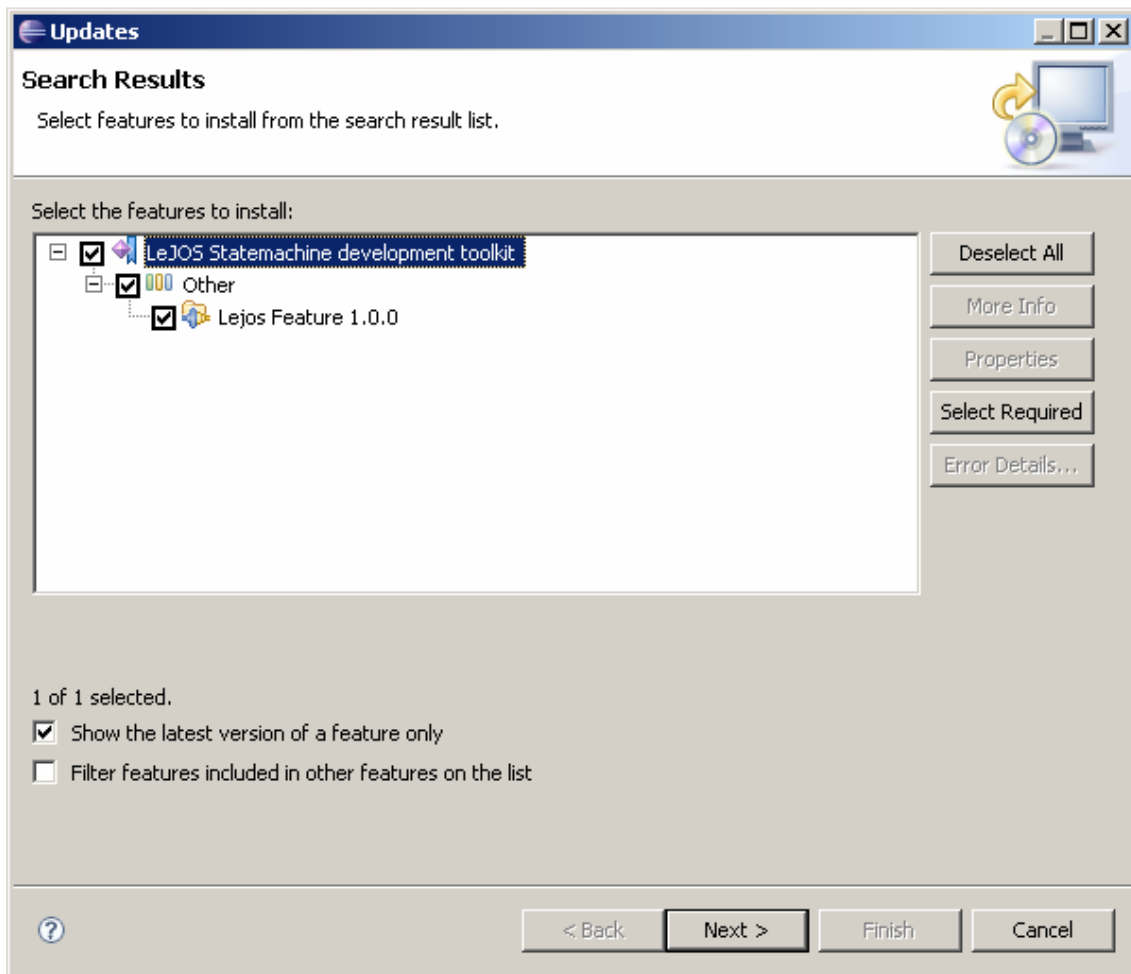

Click in "Next" button to install the toolkit. When you finish, restart the IDE.

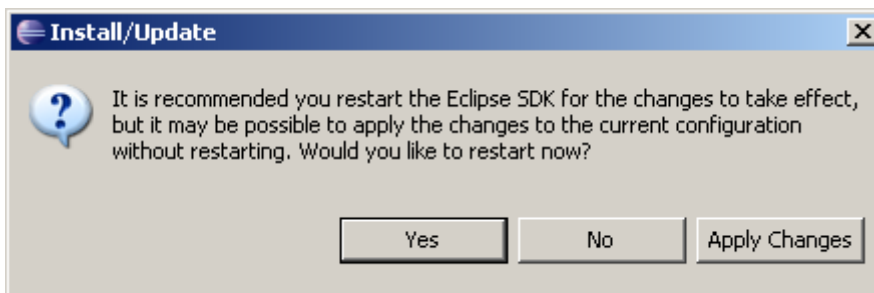

3.- Creating the first project

3.1.- Create a new project

Init Eclipse and create a new project, select the option LeJOS statemachine project.

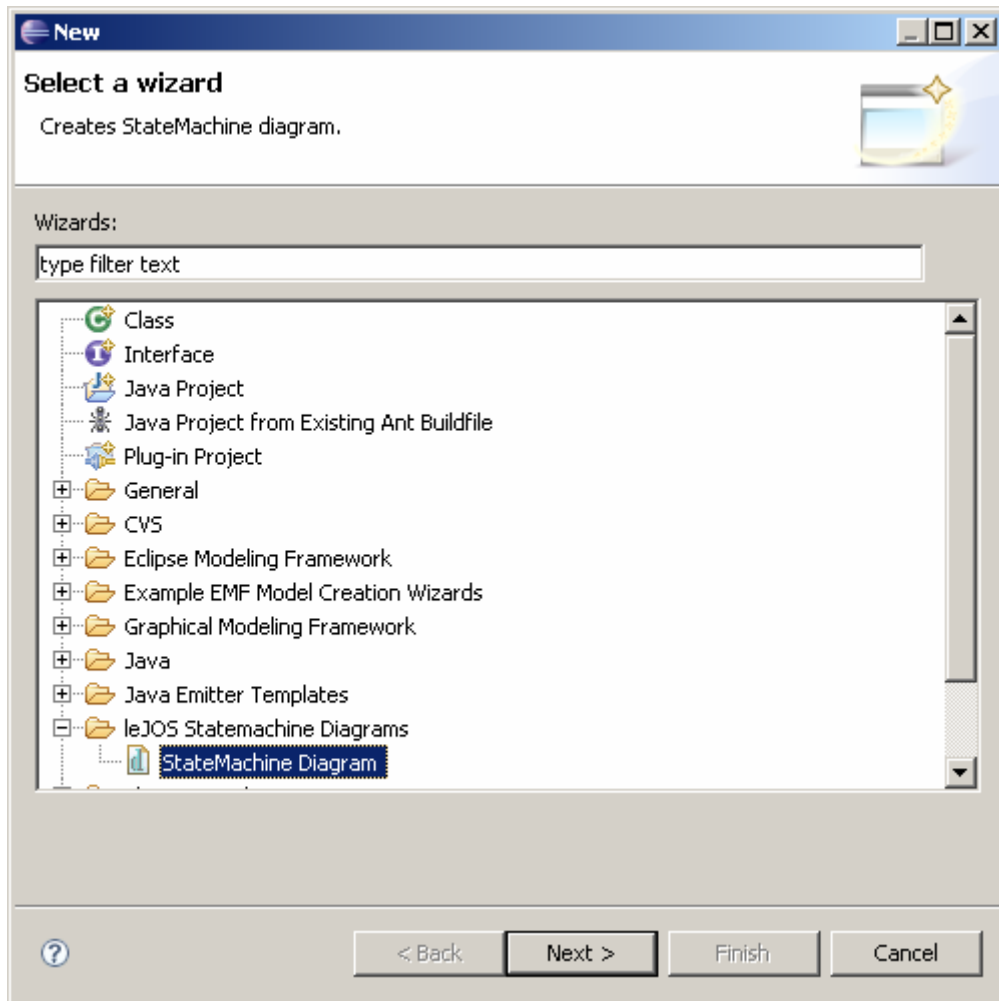

When you have created the project, it is necessary to create a State machine diagram:

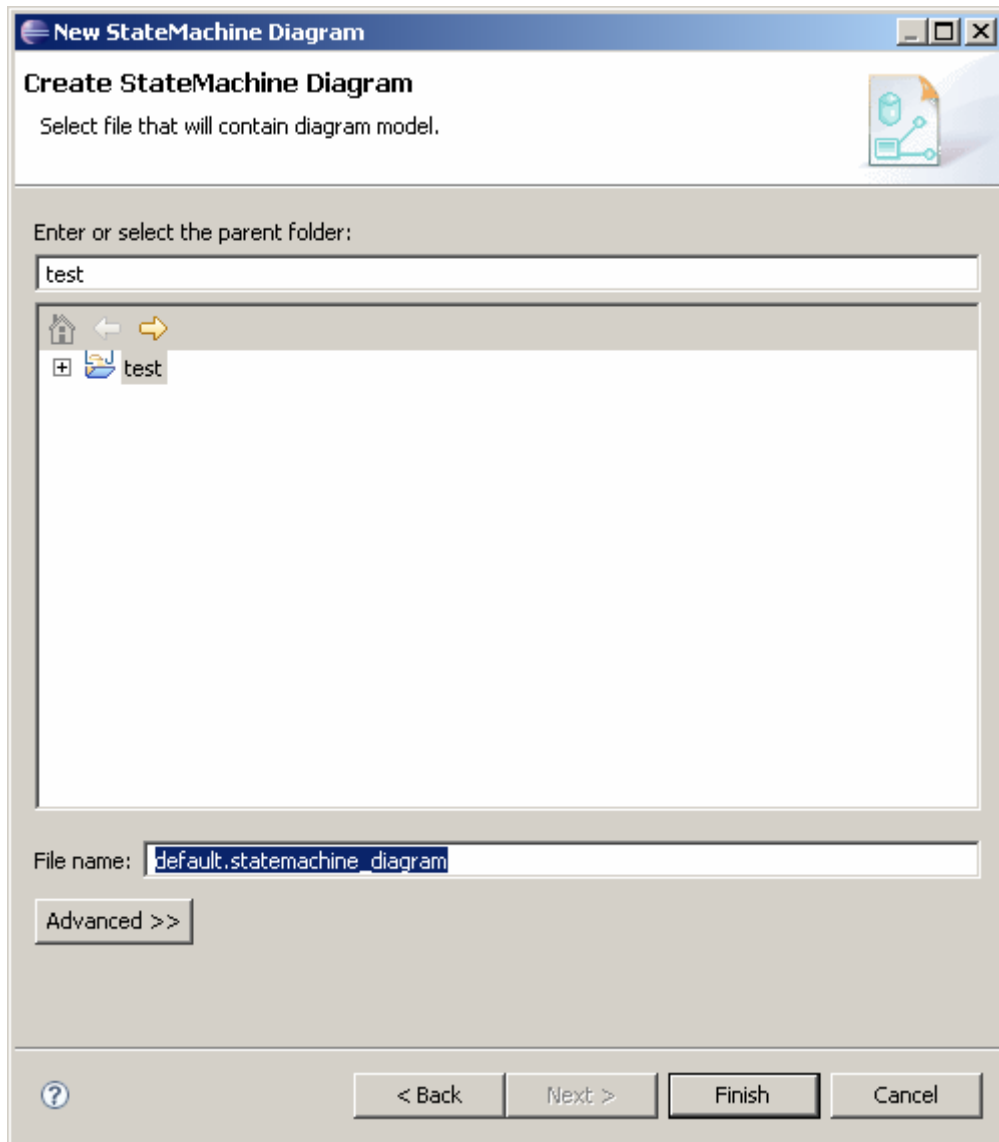

When you finish, you will see the following interface.

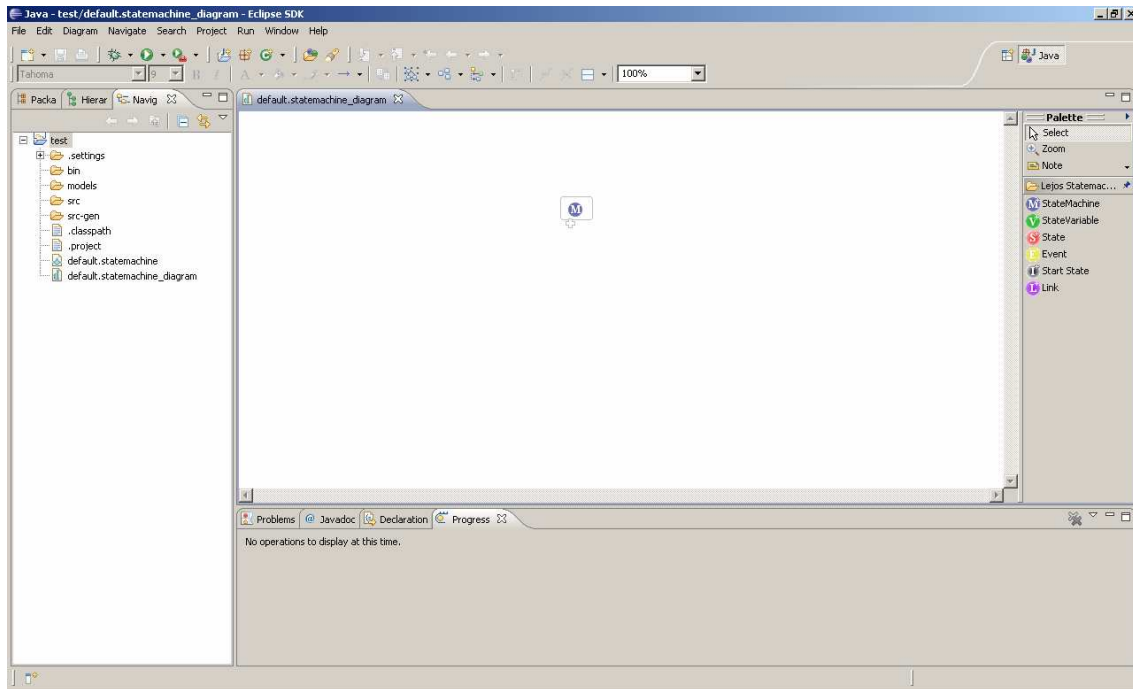

NOTE: We will update this section as soon as possible.

4.- Examples

4.1.- Videos

See the following videos using the toolkit.

http://de.youtube.com/watch?v=5_vjuUL8f1w
<http://de.youtube.com/watch?v=HiP9AQ7WF8c>
<http://de.youtube.com/watch?v=YUdxvhqILAo>